

MACmark®

Marking Films and C.A.S. Decoration Application Guide

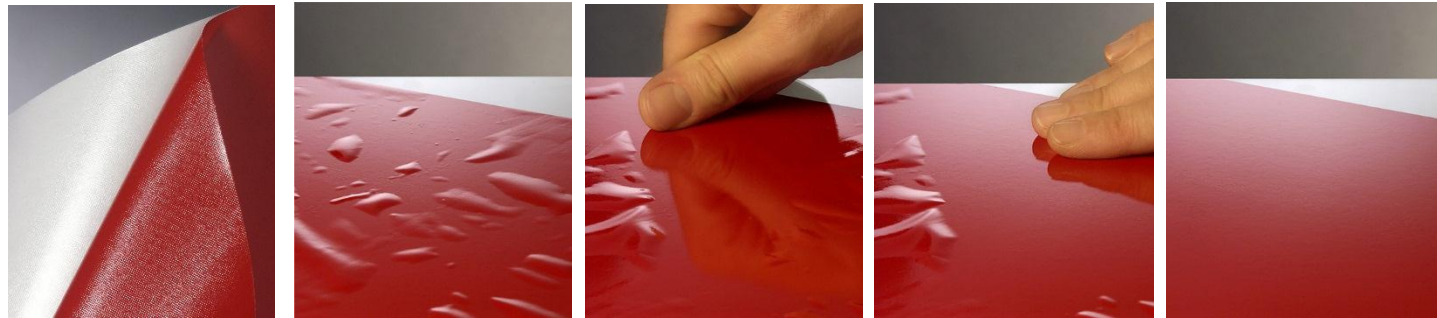

www.digitalcolorink.com

Office: 301-937-8772

Toll: 877-616-8600



High Performance Films

5 - 8 Years Long Life Exterior or Interior Markings

Typical Applications:	Fleet & Container Markings	Decorative & Vehicle Striping	Window Graphics	Decorative Panels	Illuminated Signs	Awnings & Scrims	Thermal Transfer Printing
6600	x	x		x		x	x
9800Pro	x	x	x	x			x
9700Pro			x	x	x	x	x
Glass Décor 700			x				
MAClite 5700	x	x		x		x	x

Intermediate and Specialty Films

2-3 Years Intermediate Life Exterior or Interior Markings

Typical Applications:	Promotional Launches	Exhibition Displays	Short Term Vehicle Markings	Window Graphics	Short Term (6 - 12 months) Banners	Thermal Transfer Printing
MACal 8300Pro	x	x	x	x	x	x
MACal 8900Pro	x	x	x	x		x
MACal 8400	x	x	x	x		
MACal 8000 (6-month)	x	x			x	

2. Storage

Mactac provides a two-year storage capability for MACmark films on condition that it has been kept at temperatures between 60 – 78°F (15 to 25°C) and at a humidity of 40 to 60%.



Temperature
60 – 78°F
(15 – 25°C)



Humidity
40 – 60%

Avoid directly exposing the vinyl to high temperatures (near radiators, in direct sunlight, etc.)

OK

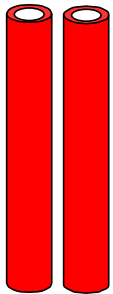

NOT OK



Any partly used rolls should be kept upright or hung on racks. At no time should they be placed on their sides as this could lead to a large matt section appearing throughout the entire roll.

3. Cutting out shapes

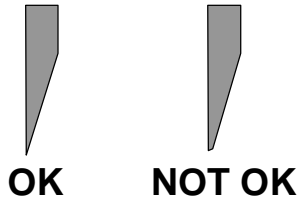

Use a knife with a sharp blade. Blunt or worn knives will result in untidy cuts (known as “jagged edging”).

OK

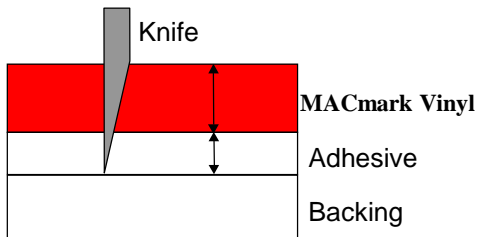

Cut to the correct depth. The knife should cut all the way through the vinyl and the adhesive.

NOT OK

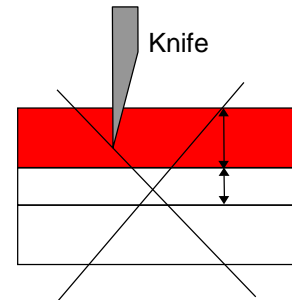

If the cut is not deep enough (the vinyl and/or if the adhesive is not cut all the way through), the letters and logos that you have cut out could be pulled away during stripping.

NOT OK

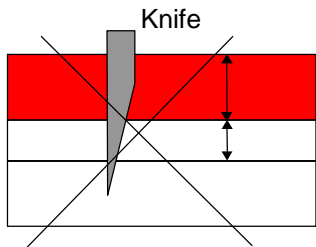

If cuts are too deep, then the backing could split when the letters or logos are being transferred onto the MACtransfer tape.

NOT OK

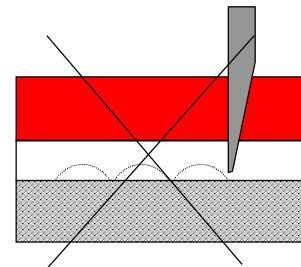

Applying too much pressure when using a blunt knife could result in the knife bouncing off the backing paper, which means that the adhesive will not be cut all the way through.

4. Weeding your graphic:



Maximum
1 hour

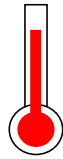

Temperature :
60 – 74°F
(15-23°C)

Mactac recommends weeding as soon as the shapes have been cut out. This is because the thickness of the adhesive layer could result in it “resealing” itself if the vinyl is left for several hours before weeding, or if it has been exposed to temperatures above 78° F(25°C).

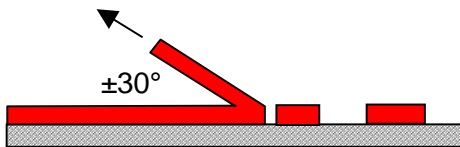

For best weeding results, use a peeling angle of approximately 30° and pull at a steady speed.

5. Applying Application Tape:

The application tape should preferably be laminated using a laminator. If this is not possible, then use the following procedure:

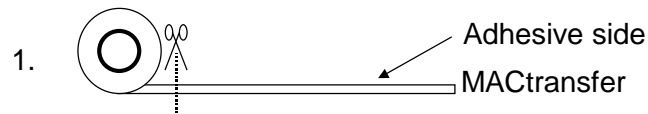

Roll the AT out on a table with the adhesive facing upwards. Cut a band wider than the lettering/ logo to be transferred.

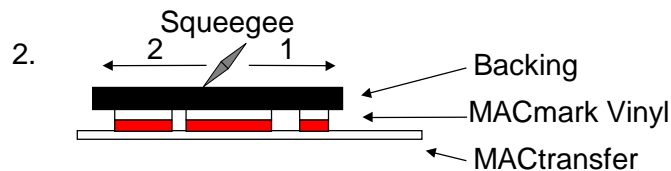

Place the lettering / logo on the AT. Squeegee the reverse side of the MACmark vinyl backing with a stiff plastic squeegee, working outwards from the center.

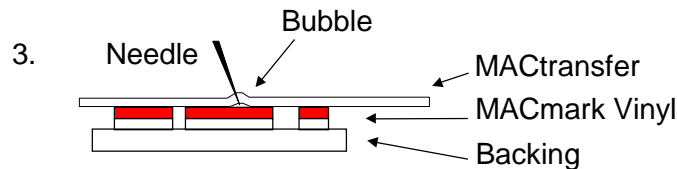

Turn the layers over and prick any air bubbles trapped between the application tape and the vinyl using a needle or a cutter (bubbles could cause wrinkling when applying MACmark to your surface).

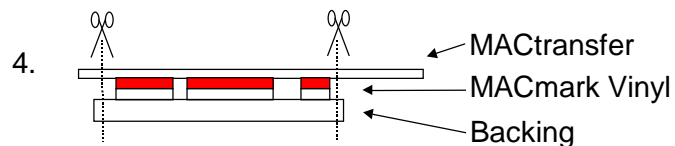

Cut the AT to the same size as the MACmark vinyl. To carry the MACmark vinyl with the AT on it to the place where it is to be applied, roll it up with a diameter of at least 3 inches, with the AT facing outwards, or carry it flat.

6. Surface Preparation:

If the adhesive is not in good contact with a clean dry surface, it will not stick and results in premature failure. Even if they appear clean, all surfaces should be cleaned using the procedure below:

- Clean with soapy water, then rinse with clean water (do not leave any traces of soap on the surface).
- Clean away any petrochemical contaminants (tar, oil, grease, etc.) using a good automotive cleaner and wax remover.
- Wipe down with isopropyl alcohol. Dry the surface using a clean lint free, dry cloth or paper towel, before the isopropyl alcohol has had a chance to evaporate.

7. Applying MACmark vinyl to the substrate:

A wet or dry application technique may be used. The method chosen should suit the size of the decorative feature to be applied and the complexity of the surface to be decorated. The dry application is the most reliable method.

7.1. Wet method:

This method of application produces very little initial adhesion. This allows the user to position the vinyl where he or she wants and avoids air bubbles and folds. The adhesion will gradually increase after several hours as the water evaporates. The final adhesion will be reached after 24 or 48 hours. It is not advisable to apply MACmark vinyls using the wet method in temperatures lower than 60°F (15 ° C).

Advantages of the wet method:

- Allows MACmark to be applied to surfaces in high ambient temperatures >78 –90°F (>25-32 °C).
- It makes it easier to apply large sections of MACmark on flat or slightly curved surfaces.



Wet applications will go much faster and easier if a professional application fluid is used instead of soap and water. However, if soap is the only option then prepare a solution of soapy water with one capful, or less, of detergent to 5 gallons of water and pour it into a spray bottle.

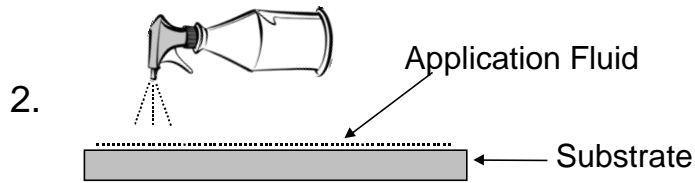

Use the spray bottle to wet the entire substrate surface (do not use a sponge or a cloth as these can leave dust, fluff, etc.).

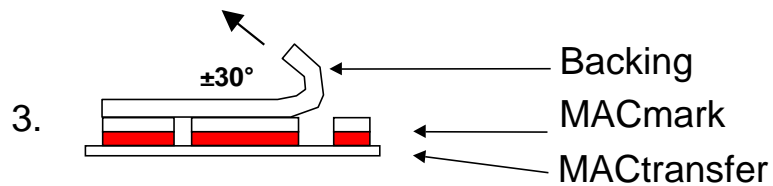

Make sure the adhesive film is flat on a table. Pull the backing off it (and not the reverse) at an angle of 30° .

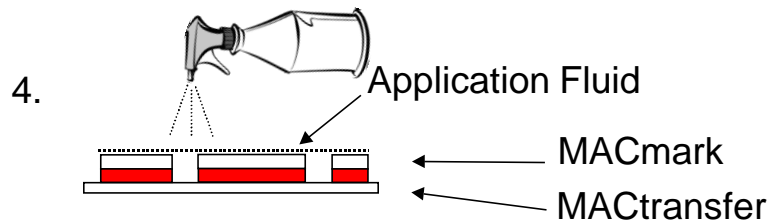

Wet the adhesive all over using a spray bottle.

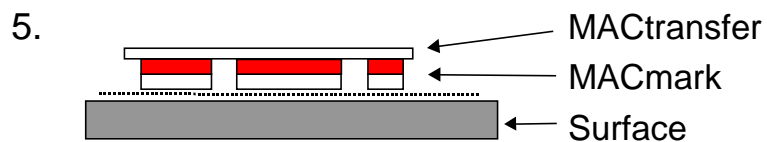

Place MACmark graphic on the wet substrate surface.

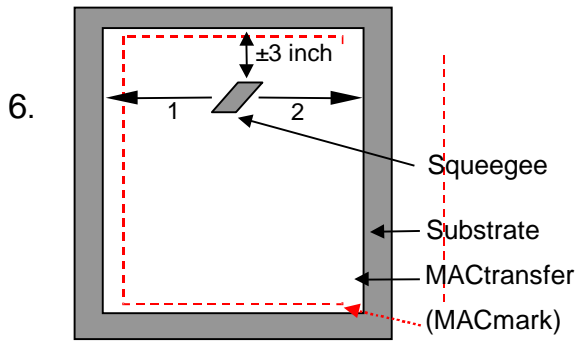

Squeegee horizontally, working from the center outwards to the left and then the right stopping ± 3 inches from the top edge of the vinyl. Apply enough pressure to squeeze out any water trapped between the MACmark adhesive and the substrate surface.

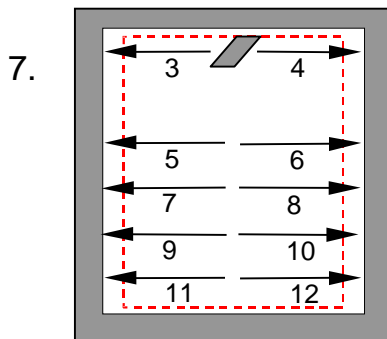

Squeegee the last 3 inches of the top edge working from the center outwards, to the left and then the right. Continue to squeegee horizontally moving from the center outwards with overlapping movements. Check that no pockets of water have been trapped. If this is the case, scrape from the center to the edge in order to squeeze it out. Wipe the vinyl and the edges.

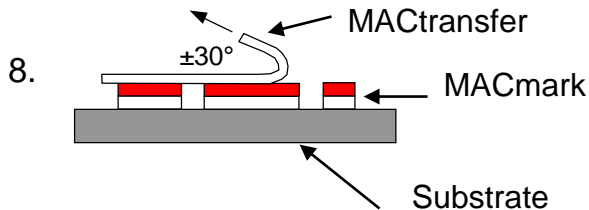

It is advisable to wait between 30 and 90 minutes (depending on the ambient temperature) before removing the application tape. Pull it off at a steady speed, at approximately 30° .

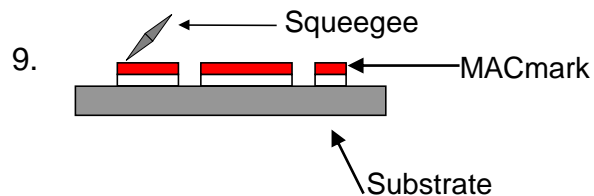

24 hours later squeegee the film again, paying particular attention to the edges.

Dry method

Dry application is a safer application method because the marking film reaches its final adhesion more quickly than during wet application. This application method should be used on three-dimensional surfaces that require the vinyl to be shaped (over rivet heads, corrugations, welded areas, etc.).

The lowest temperature at which MACmark vinyls should be applied on flat or slightly curved surfaces is 50°F (10 ° C). The lowest temperature at which MACmark should be applied on three-dimensional surfaces, which require the vinyl to be shaped, is 65°F (18° C). Hot air will need to be used.

Small surface areas (< 5 ft² or 0.5 m²)

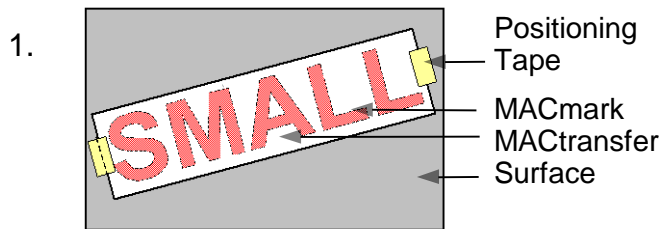

Place the application tape on top of the lettering or logo. Position the lettering or the logo **WITHOUT REMOVING THE BACKING**, using positioning tape at each end.

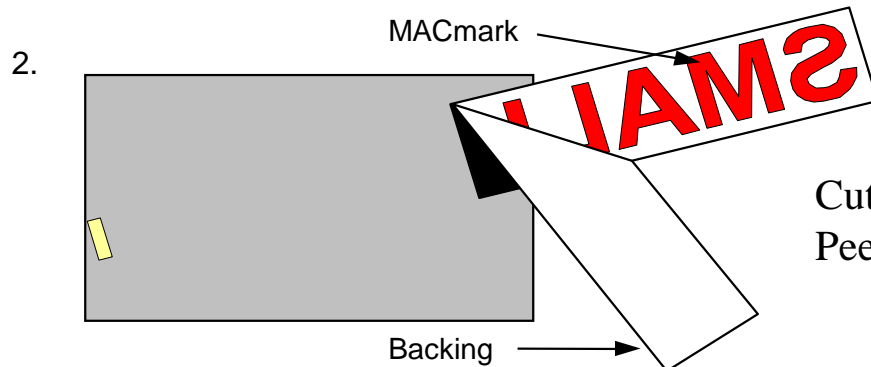

Cut one edge of the positioning tape. Peel the backing off.

3.

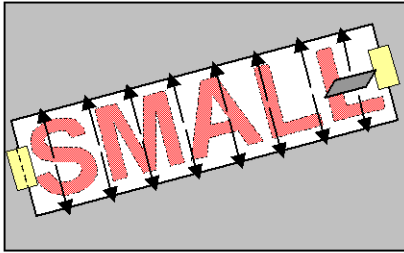

Position the lettering or the logo once again on the spot marked by the piece of positioning tape. Squeegee quickly and firmly from the center outwards in overlapping movements.

4.

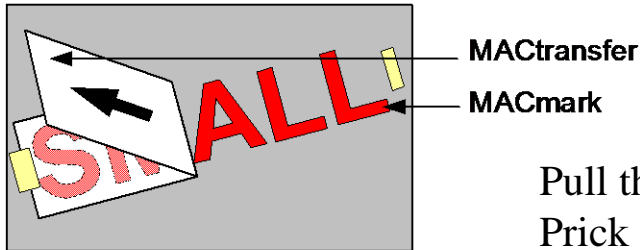

Pull the AT off at steady speed, at an angle 30°.
Prick any air bubbles (*) trapped between the MACmark and the substrate.

(*) In the event that “tiny bubbles” of air get trapped between the MACmark vinyl and the substrate surface (bubbles that have a diameter <2-mm), there is no need to do anything since they will disappear of their own after few days thanks to the vinyl’s porosity.

If the bubbles are over 2 mm in diameter, use the following procedure:

- 1 - try to collect the bubbles together without putting the vinyl out of shape.
- 2 - prick the bubble at one end.
- 3- squeeze the air out from the side opposite the opening.

Large flat surfaces (>10ft² or 1 m²) : hinge method

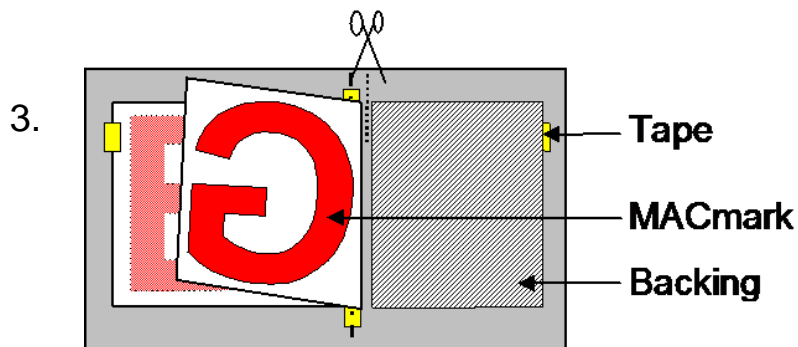
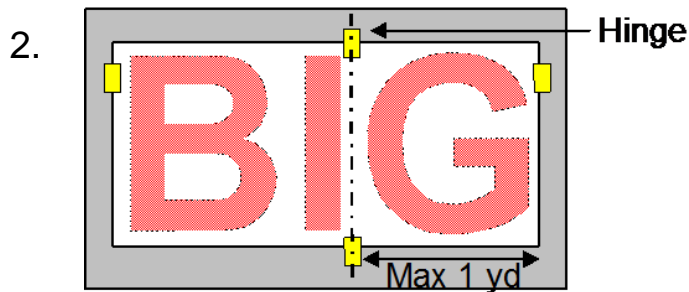
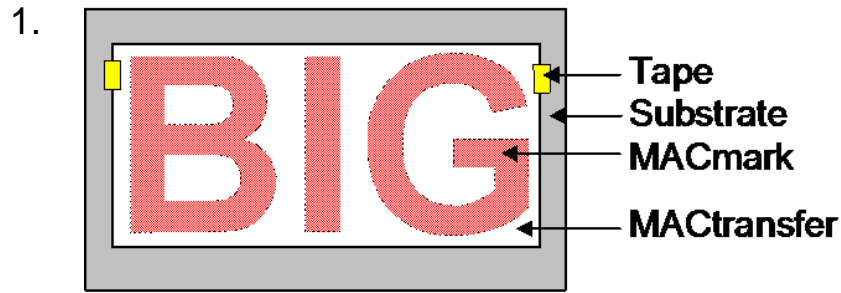

For surfaces of this kind, it is absolutely necessary to apply AT to the lettering or logo. Position the lettering or the logo **WITHOUT REMOVING THE BACKING** by using a piece of positioning tape at each end.

Make a hinge perpendicular to the largest dimension of the letters or logo, no more than 1yd. (1m) away from any one of the edges.

Cut the positioning tape. Fold one half on top of the other. Remove and cut the backing as far as the hinge.

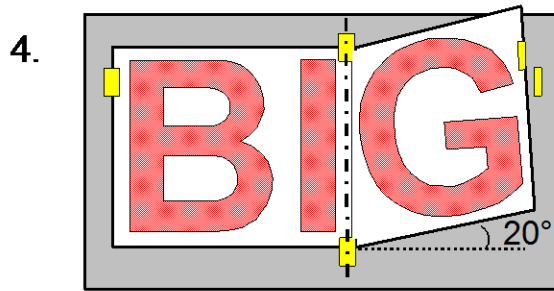

Fold the hinge back making sure that you leave a space between the MACmark vinyl and the substrate surface (angle of $\pm 20^\circ$) in order to avoid it sticking too soon.

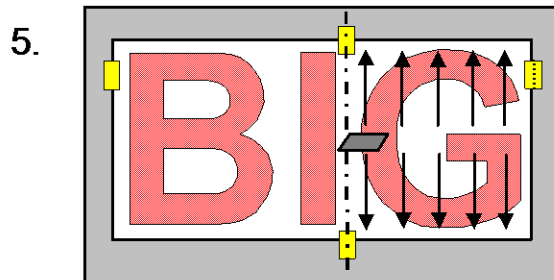

Squeegee firmly from the center outwards in overlapping movements.

Repeat the same set of actions for the other section of the lettering or logo.

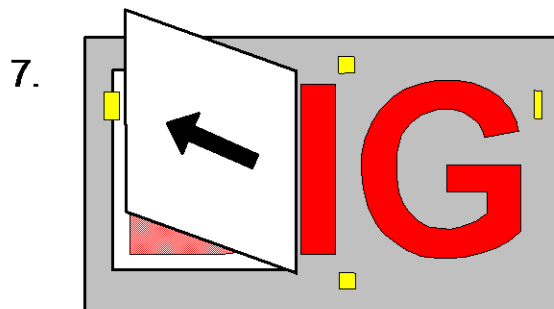

Remove the AT at a steady speed, at a cleaving angle of between 0 and 30° .

Prick any air bubbles trapped between the MACmark and the substrate and squeegee once more.

3 dimensional surfaces : Rivets

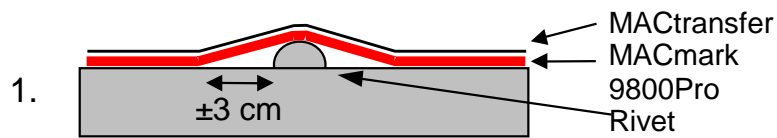

Apply the MACmark, using the dry method described earlier, to the whole area of the surface of application, leaving a ± 3 cm gap between the vinyl and the substrate, around rivets.

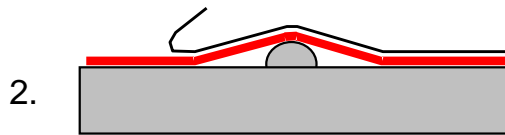

Remove the application tape at a steady speed and a cleaving angle of 0 to 30°.

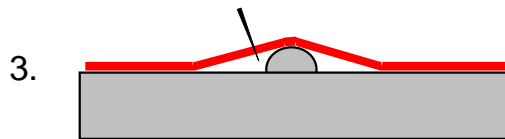

Collect the bubble around the rivet without putting the vinyl out of shape. Prick several holes in the vinyl around the rivet.

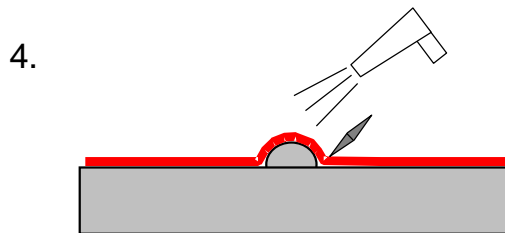

Squeeze out any air trapped between the MACmark and the rivet using your finger. Press the vinyl down hard around the rivet using a rivet brush or plastic squeegee and a heat gun or hot air blower (air temperature of $\pm 300^{\circ}\text{C}$).

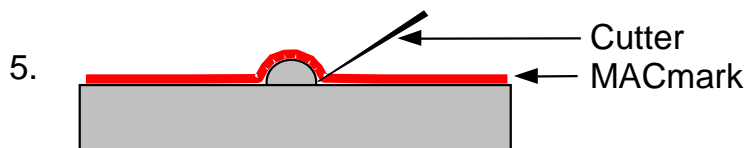

Finish off by cutting the MACmark around the rivet using a cutter.

3 dimensional surfaces: corrugations

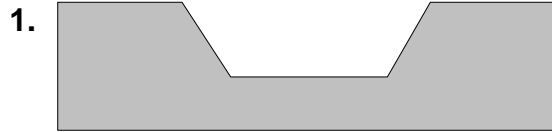

Temperature – angled surface : 18-25°C

The ambient temperature and the angled surface of the object must be between 18 and 25°C. Clean the substrate surface and remove any grease using isopropyl alcohol.

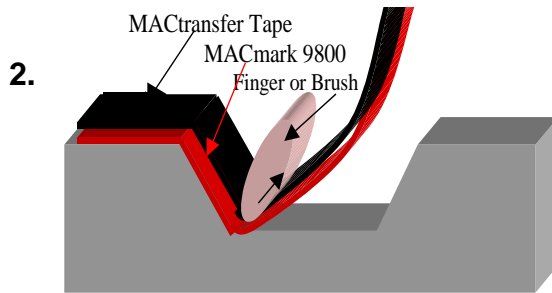

Apply MACmark 9800Pro using MACtransfer application tape through the 3 dimensional surface. Use your finger or a stiff bristle nylon brush, (cut off to approximately $\frac{3}{4}$ ") along the lines of the corrugations to make the vinyl conform to the curved surface.

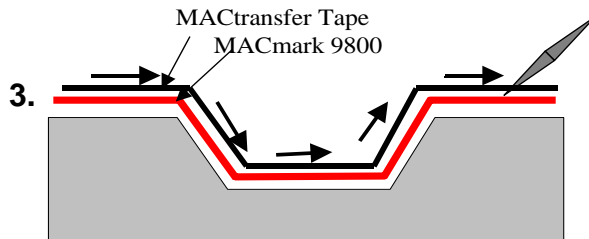

The application tape is used to give more stability to the vinyl during the first stages of application.

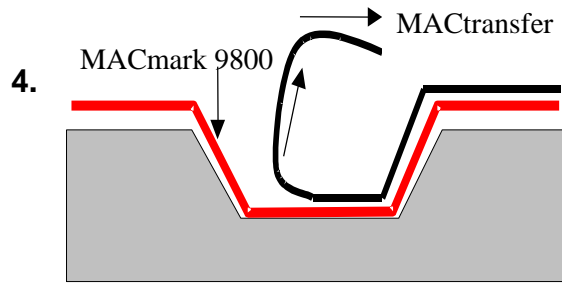

Remove the AT. Prick and squeeze out any air bubbles that appear.

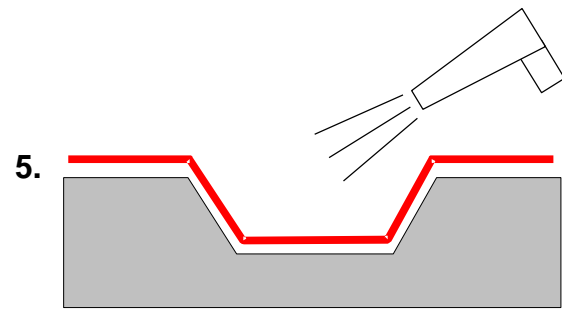

Once 100% of the vinyl is in contact with the surface, **heat the vinyl with heat gun or hot air blower** (air temperature: 350-400°C). This reinforces the initial adhesion. The decoration should not be exposed to temperatures lower than 10° C during the first 3-4hours.

- If you need to apply a second color, leave the first MACmark 9800color applied for 20 to 30 minutes, then apply the second color. Using a double layer of vinyl increases the risk of the vinyl peeling off. Heat should be used, as described earlier, in order to minimize the chances of this happening.
- Adhesion to plastics such as ABS, PP or rubber is always difficult. Do not decorate surfaces of this kind if you require long-life decoration.

Finishing your Graphics

8.1 Seams



Seams will hold moisture and flex resulting in a pre-mature failure of your graphic. All seams must be slit the entire length of the substrate. If the seam is caulked the graphic will not adhere. The section of the graphic must be cut and removed.

8.2 Applying Edge Sealer



Edge sealing is required wherever your graphic is going to be repeatedly exposed to liquids that will attack the adhesive, such as fuel, solvents, milk, etc. Using a 1/4" brush and an edge sealing varnish, brush along the edge in smooth, continuous motion. Make sure the entire edge is sealed.

8.3 Cleaning

Use a wet non-abrasive type cleaner. Similar to ones used for painted surfaces. Strong acid, strong alkaline or strong solvent cleaners will damage your graphics.

Removing the vinyl

1. Heat the vinyl to a temperature of 160-175°F (70-80° C) using a hot air blower (air temperature of $\pm 575^{\circ}\text{F}$ or 300°C).
2. Peel off the MACmark in small pieces at a time.
3. Chemical products for easier vinyl removal are also available through your distributor in the shops. Follow the manufacturer's Instructions carefully.
4. Any residue of adhesive can be removed by rubbing with a towel soaked in isopropyl alcohol or adhesive remover.

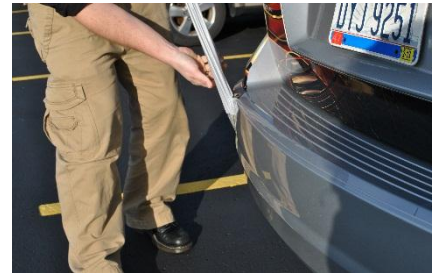
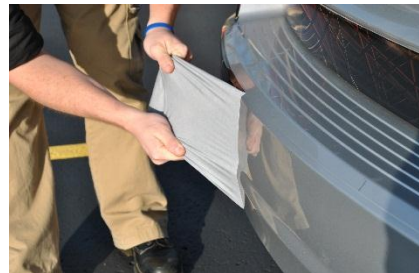

Product	Outdoor Durability	Mil	Colors	Typical Uses	Characteristics	Application Method					
						Dry	Wet	Flat	Curved	Corrug.	Rivets
MACcast® 6600	7-8 years	2 mil	63 gloss opaque 5 metallic 2 matte opaque	- Long-term outdoor advertising - Fleet marking - Window graphics - Decorative panels - Logos and signs	- High-performance cast vinyl - Excellent conformability on complex curves	EX	EX	EX	EX	EX	EX
9800PRO	7-8 years	2.8 mil	59 gloss 2 matte	- Long-term outdoor advertising - Fleet marking - Window graphics - Decorative panels - Logos and signs	- High-performance polymeric vinyl - Good conformability on moderate curves	EX	EX	EX	EX	GD	GD
9700PRO	5-7 years	3 mil	34 matte	- Backlit signs - Awnings	- High-performance polymeric translucent vinyl - Excellent dimensional stability and color uniformity	VG	EX	EX	VG	NR	NR
8900PRO	4-5 years	2.8 mil	7 gloss 7 matte	- Transit graphics - Tradeshow graphics - Museum displays and windows	- Intermediate monomeric vinyl with cleanly removable adhesive for up to 2 years - Can be applied down to 32°F	VG	NR	EX	GD	NR	NR
8400	3 years	3 mil	10 gloss	- Graphics shadowing - Illuminated signage	- Medium-term transparent vinyl	NR	EX	EX	GD	NR	NR
8300PRO	4-5 years	2.8 mil	32 gloss 2 matte	- Promotional signage (flat surfaces) - Window graphics - Banners - Display graphics	- Permanent intermediate monomeric vinyl - Economical alternative	EX	EX	EX	VG	PS	NR
8000	3-6 months	3 mil	5 satin	- Temporary eye-catching graphics - Window graphics - Point of purchase - Banners - Exhibit walls	- Short-life fluorescent vinyl - Semi-permanent adhesive for clean removability	VG	NR	EX	GD	NR	NR
MAClite® 5700	5-7 years	6 mil	8 gloss	- Vehicle markings - Safety signs	- High optical quality - Excellent night and day visibility	EX	EX	EX	EX	EX	EX
Glass Décor 700	5 years	3 mil	2 matte	- Frosted window decoration simulates etched glass or sand blasted look	- High-performance polymeric translucent vinyl	EX	EX	EX	VG	NR	NR

Key			
EX	Excellent	PS	Possible
VG	Very Good	NR	Not Recommended
GD	Good		

Product	Mil	Code	Typical Uses	Characteristics	Application Method					
					Dry	Wet	Flat	Curved	Corrug.	Rivets
Application Tape	4 mil	210	- Large-format screen or digital image transfer tape	- Medium-tack, large-format, paper	VG	VG	EX	EX	EX	EX
	4 mil	220	- Sign letter transfer	- High-tack, signage, paper	VG	VG	EX	EX	EX	GD
	5 mil	230	- Sign letter transfer	- Medium-tack, signage, clear polyethylene	VG	NR	EX	EX	GD	GD



www.digitalcolorink.com
Office: 301-937-8772
Toll: 877-616-8600

For more information regarding Mactac products or graphic solutions, call 866-622-8223, email mactac.americas@mactac.com or visit www.mactac.com/graphics and www.theapplicationnation.com.

MAC1766 (11/14)

